



---

# VISIO

---

**FILLING CHECK VERSION  
WITH LEVEL SENSOR**

*Software rel. 2.3.x*

---

# CONTENTS

• Legend of symbols .....	3
<b>INTRODUCTION .....</b>	<b>4</b>
Product description .....	4
<b>INTENDED USE .....</b>	<b>4</b>
<b>CONTENT OF THE PACKAGE .....</b>	<b>4</b>
<b>PRECAUTIONS .....</b>	<b>4</b>
<b>RISKS AND PROTECTIONS BEFORE ASSEMBLY .....</b>	<b>5</b>
Positioning .....	5
Power supply and sensor connection .....	5
<b>ASSEMBLY DIAGRAMS .....</b>	<b>6</b>
<b>CONTROLS IN THE MENU .....</b>	<b>7</b>
First switching on .....	7
Controls in the menu .....	8
Work parameters .....	9
<b>MENU STRUCTURE .....</b>	<b>10</b>
<b>PRELIMINARY SETUP FOR USE .....</b>	<b>11</b>
Alarms .....	11
Sensors .....	13
Flowmeter calibration (TO BE USED FOR AUTOMATIC TANK CALIBRATION ONLY) .....	14
Tank .....	15
Tank calibration .....	16
Load/Save tank .....	21
Language .....	23
Units of measurement .....	24
Display contrast .....	25
Alarm tones .....	26
Keytones .....	26
Filling tolerance .....	27
CAN communication .....	28
Operating mode .....	29
Setup management .....	30
Test menu .....	32
<b>USE .....</b>	<b>35</b>
<b>MAINTENANCE / DIAGNOSTICS / REPAIRS .....</b>	<b>37</b>
Troubleshooting .....	37
<b>END OF LIFE DISPOSAL .....</b>	<b>37</b>
<b>TECHNICAL DATA .....</b>	<b>38</b>
Device technical data .....	38
Setup menu .....	39
<b>GUARANTEE TERMS .....</b>	<b>40</b>



= **Generic danger**



= **Warning**

*This manual is an integral part of the equipment to which it refers and must accompany the equipment in case of sale or change of ownership. Keep it for any future reference; ARAG reserves the right to modify product specifications and instructions at any moment and without notice.*

## INTRODUCTION

### Product description

VISIO is a very compact and accurate top-notch multifunction display, able to display any kind of information concerning agricultural treatments.

Operator can select the required function via software.

It can display several types of values, which change according to set operating mode and type of connected sensors.

### INTENDED USE

This device is designed to work on agricultural machinery for spraying and crop spraying applications.

**CE** The machine is designed and built in compliance with EN ISO 14982 standard (Electromagnetic compatibility - Forestry and farming machines), harmonized with 2004/108/EC Directive.

### CONTENT OF THE PACKAGE

The table below indicates the components that you will find in the VISIO package:

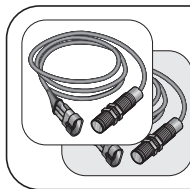

Power cable, sensors and connection cables to be connected to VISIO must be ordered separately.

#### Legend:

- 1 VISIO
- 2 Fixing kit
- 3 Instruction manual (on CD-ROM)
- 4 Installation sheet

### PRECAUTIONS



- Do not aim water jets at the equipment.
- Do not use solvents or fuel to clean the case outer surface.
- Do not clean equipment with direct water jets.
- Comply with the specified power voltage (12 VDC).
- In case of voltaic arc welding, remove connectors from VISIO and disconnect the power cables.
- Only use ARAG genuine spare parts and accessories.

## RISKS AND PROTECTIONS BEFORE ASSEMBLY



All installation works must be done with battery disconnected, using suitable tools and any individual protection equipment deemed necessary.

### Positioning

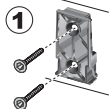

1) Set mounting rail in cabin and fasten it with the relevant screws (1), in a position where VISIO can be easily seen and at hands' reach, but away from any moving organs.

2) Secure VISIO to rail and push down until locked in place.

3) Fasten wiring so that it does not interfere with any moving parts.

### Power supply and sensor connection





Sensors and power supply must be installed and connected by qualified personnel. VISIO must be exclusively connected to ARAG equipment.

**WHEN ARC WELDING IS REQUIRED, MAKE SURE THAT EQUIPMENT POWER IS SWITCHED OFF; DISCONNECT POWER CABLES IF NEEDED.**

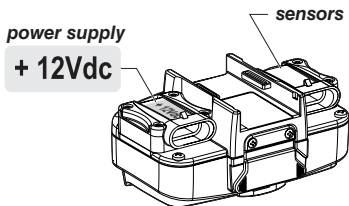

ARAG is not liable for damage to the system, persons, animals or property caused by VISIO wrong or unsuitable assembly. Failure to observe the above instructions automatically voids the warranty.



Wire color (power cable)	Connection of
red	 positive
black	 negative
green	counting abort - ground connection
yellow	counting abort - connection +12VDC

## STANDARD SYSTEM

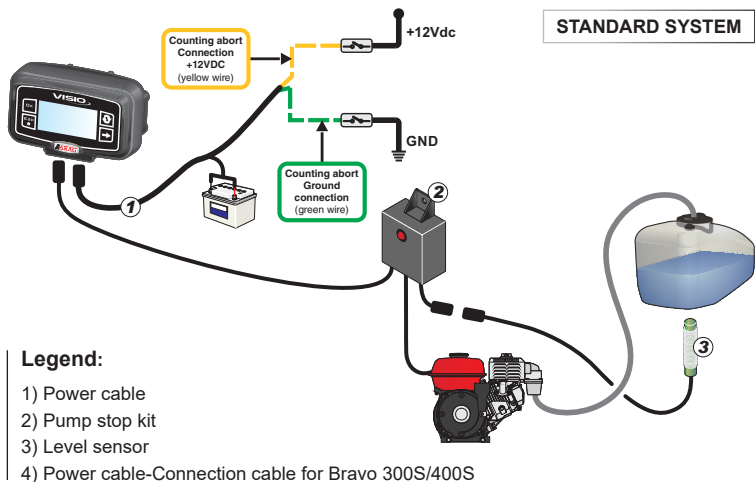

## SYSTEM WITH RCU



## CONTROLS IN THE MENU

---

### First switching on

---



At first switching on, VISIO will run a guided procedure allowing user to set the device's basic settings.

Press  to scroll through items, **OK** to save and move on to next setting, or **ESC** to go back to previous setting.



**WARNING:** Before changing operating mode, make sure that all sensors / flowmeters are DISCONNECTED from the device.



In the following pages, according to the set operating mode, some menu items could slightly differ from the shown ones.

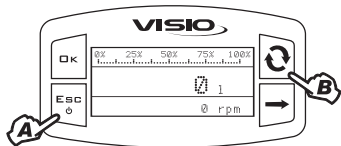

### SWITCHING ON

**A** Press for 1 second

**B** Press the key a few times to view the various values in extended mode (on display central part)

Every time the device is switched on, it will shortly show a page with the name of device and software version

### SWITCHING OFF

**A** Press for 2 seconds

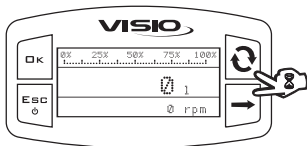

### ACCESS TO SETUP MENU

From the main page, press keys at the same time for 2 seconds to open the Setup Menu



### SELECTION AND ACCESS TO MENU ITEMS

**A** Press a few times to scroll through items (selected item is indicated by a black line)

**B** Press to open the selected menu item



The three dots under an item indicate presence of another setup menu





## EDITING A VALUE

- A** Press to move through digits
- B** Press a few times to edit the highlighted digit
- C** Press to confirm. The display goes back to previous page
- D** Press to exit page without confirming modification



**Edited value must fall within the range shown**

## Work parameters

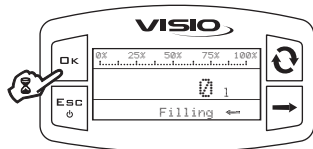

From the main page, press key for two seconds to open **Work Parameters** menu, and set values for **Level correction**.

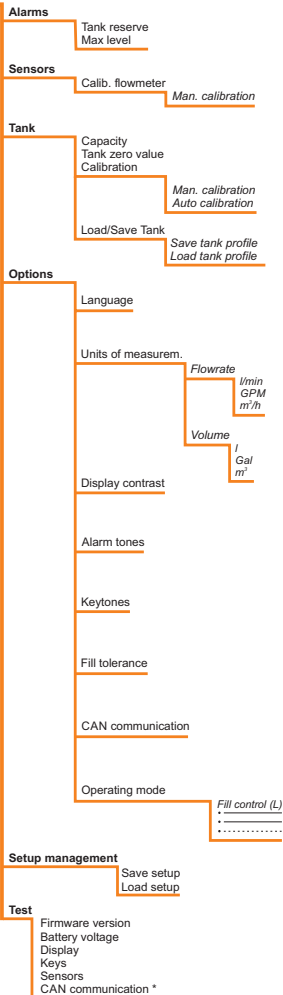
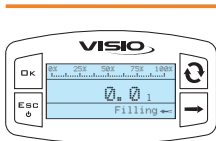

\* Menu item active only if  
CAN communication is active.

## Alarms

Set the desired alarm display thresholds.

### Tank reserve alarm

Set the value of the minimum fluid quantity left in the tank.





1) Open tank reserve alarm menu (Setup menu > Alarms > Tank reserve).

**The display will show the current setting below the selected item.**

Press **OK** to edit the selected menu item



2) To deactivate the alarm, press  and

 at the same time until the set value disappears and the message **OFF** is displayed instead.

Carry out the same procedure to enable alarm again.



3) Set alarm value:

A) Press  to move through digits.

B) Press a few times to edit the highlighted digit.

C) Press  to save changes, or

D) Press  to quit the page without confirming changes.

## Max tank level

Set the maximum tank capacity percentage value for the desired alarm activation threshold.



1) Open tank max level menu (Setup menu > Alarms > Max level).

**The display will show the current setting below the selected item.**

Press **OK** to edit the selected menu item.

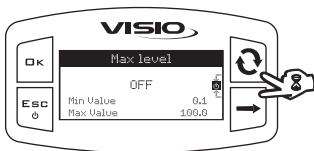

2) To activate the alarm, press  and

 at the same time until the message **OFF** goes off and the alarm value is displayed instead.

Carry out the same procedure to disable alarm again.



3) Set alarm value:

A) Press to move through digits.

B) Press a few times to edit the highlighted digit.

C) Press to save changes, or

D) Press to quit the page without confirming changes.

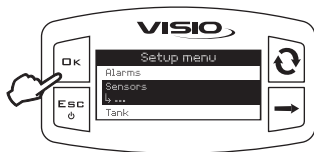

1) Open Sensors menu (Setup menu > Sensors).

The menu items displayed below change according to the set operation mode: when more items are available, select the desired one and press **OK** to edit it.

## Flowmeter calibration

(TO BE USED FOR AUTOMATIC TANK CALIBRATION ONLY)



Due to the different system configurations (tubes, valves, etc.) rate reading could not be correct. It is therefore recommended to perform a spraying test. If measured value is different from actual value, change the rate constant through an automatic calibration procedure or manually calculate the constant.

### Manual calibration

In order to manually set rate constant, calculate and set suitable constant using the following formula:

$$\frac{[\text{quantity measured by equipment}]}{[\text{actually sprayed quantity}]} \times [\text{constant indicated on flowmeter body}]$$

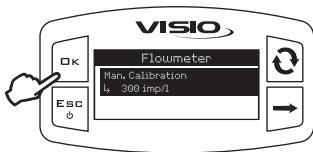

- 1) Open manual calibration menu (Setup menu > Calibration > Man. Calibration). **Under Calibration menu, select Man. Calibration, to view currently set constant value below the item. Press OK to edit the value.**



- For flowmeter constant value, refer to the corresponding manual.**
- 2) Set flowmeter constant value:
    - A) Press to move through digits.
    - B) Press a few times to edit the highlighted digit.
    - C) Press to save changes, or
    - D) Press to quit the page without confirming changes.

## Tank

From this menu it is possible to view and set a number of tank values.

### - Capacity:

the display shows the maximum tank capacity value, as previously calculated through calibration. **This value is read-only.**

### Tank zero value

Set level sensor zero value.

**The level sensor must be reset in the following cases:**

1) If there are discrepancies between the quantity of fluid in the tank and the value measured by the level sensor (e.g., fluid presence detected but empty tank).

2) **EVERY TIME** a calibration curve is uploaded via USB.

**The tank zero value must ALWAYS be saved WITH AN EMPTY TANK.**

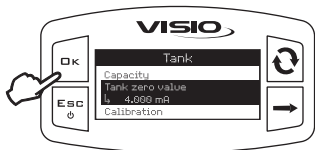

1) Open tank zero value menu (Setup menu > Tank > Tank zero value).

**The display will show the current setting below the selected item.**

Press **OK** to edit the selected menu item.

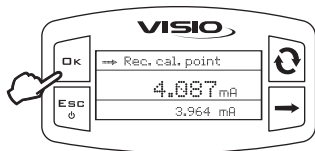

2) Press **OK**: VISIO will save the level sensor zero value, which will be shown in the bottom part of the display (e.g., **3.964 mA** in the image on the side).

**If a sensor malfunction occurs, the message Check sensor! will be shown in the top part of the display.**

## Tank calibration

The tank profile calibration can be carried out in manual or automatic mode. During calibration, VISIO will save up to 200 calibration points to create the tank profile curve.

If necessary, the tank profile can be saved and reimported into VISIO or compatible ARAG Computers (Bravo 180S/300S/400S) at a later time (e.g., when reusing the same tank).

Before starting the procedure carry out the following operations:

- 1) Fill the tank with clean water WITHOUT ADDING CHEMICAL SUBSTANCES. The tank must be full.
- 2) Visually check the reached level.

### Automatic tank calibration

 Automatic calibration is possible only if the system is equipped with a flowmeter.

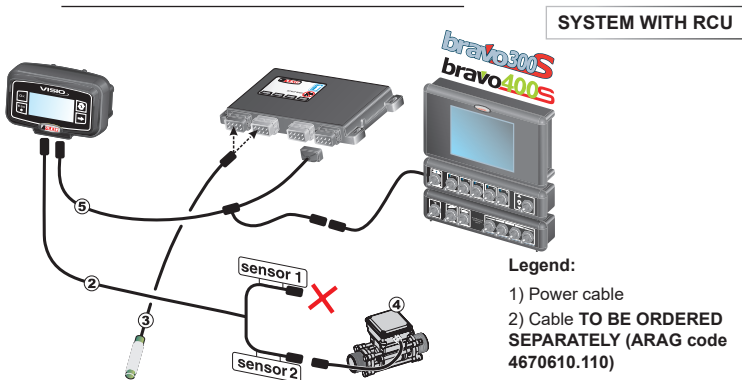
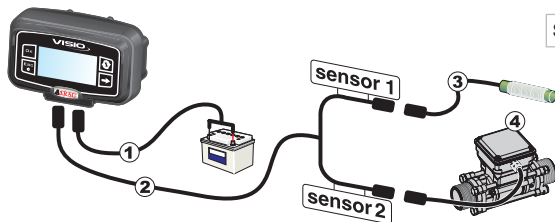

#### Legend:

- 1) Power cable
- 2) Cable **TO BE ORDERED SEPARATELY (ARAG code 4670610.110)**
- 3) Level sensor
- 4) Flowmeter
- 5) Power cable-Connection cable for Bravo 300S/400S





- 1) Open automatic calibration menu (Setup menu > Tank > Auto calibration).  
Press **OK** to edit the selected menu item.



- 2) Set the tank maximum capacity value, i.e., the theoretical quantity of fluid that was previously introduced:  
A) Press **→** to move through digits.  
B) Press a few times to edit the highlighted digit.  
C) Press **OK** to save changes, or  
D) Press **ESC** to quit the page without confirming changes.

**As soon as menu is open, the equipment is ready to start measuring with no further controls being required.**

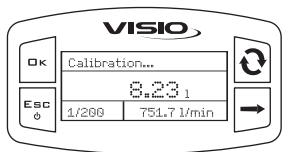

- 3) Start tank draining.  
The display will start showing the increasing **measured fluid quantity** value (central area of the display), the **instant flowrate** value (bottom right), and the progressive number of measured **calibration points** (bottom left).



**If a sensor malfunction occurs, the message `Check sensor!` will be shown in the top part of the display.**

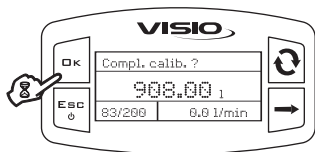

4) Once the tank has been completely drained, the value in the central area of the display will stop changing, and the message **Compl. calib. ?** will appear in the display top part. Press **OK** for 1 second to complete calibration.



5) The display will go back to the previous menu and will show the acquired value. In case of measurement errors, or if it is necessary to stop the calibration, press **ESC** for 2 seconds to quit the calibration procedure without saving. In this case, the curve will be the one previously measured, or the default curve.

To perform manual calibration, proceed as follows:

1) Calculate the suitable calibration interval with respect to tank maximum capacity, bearing in mind that:

- it is possible to save up to 200 calibration points;
- a high number of calibration points makes for more accurate measurements.

2) Adopt a reliable method for measuring the fluid quantity that was previously calculated.

**Example:**

$$\frac{[2000 \text{ liters}]}{[200 \text{ points}]} = [10 \text{ liters}]$$

[2000 liters] = *maximum tank capacity*;

[200 points] = *set calibration points*;

[10 liters] \* = *measurement value in liters*.

**\* IMPORTANT:** Set a measurement value that is slightly higher (e.g., 11 liters) than the formula, in order to make up for any errors in the evaluation of tank maximum capacity.



1) Open manual calibration menu (Setup menu > Tank > Man. Calibration). Press **OK** to edit the selected menu item.

**As soon as menu is open, the equipment is ready to start measuring with no further controls being required.**



2) Start tank draining.

Once the measurement container is full, stop draining and, in the display central part, enter the volume of the drained fluid with respect to the previous calibration point:

A) Press to move through digits.

B) Press a few times to edit the highlighted digit.

C) Press to confirm.



The message **Stabilization** will appear in the display top part for a few seconds, then it will switch back to **Rec. cal. point**.

The value of calibration points will increase by one unit, and the value of the progressively drained partial volume will show the quantity of fluid measured up to that moment.

VISIO is ready for a new measurement.



**It is possible to save calibration points obtained with different quantities of drained fluid.**

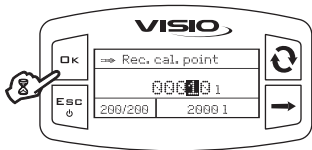

4) Once the tank has been emptied completely, press **OK** key for 1 second to complete the calibration process and save the relevant curve.



5) The display will go back to the previous menu and will show the acquired value.

In case of measurement errors, or if it is necessary to stop the calibration, press **ESC** key for 1 second to quit the calibration procedure without saving. In this case, the curve will be the one previously measured, or the default curve.

## Load/Save tank

The tank calibration can be saved or loaded onto a USB pen drive, in order to restore it if required, fix problems or set another VISIO with no need to repeat all calibration operations.

 Once installation is completed, check VISIO operation and it is recommended to save the tank configuration on a USB pen drive.

To load or save the calibration curve it is necessary to insert a USB pen drive in the relevant port at the bottom of VISIO.

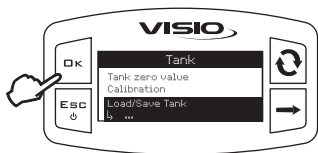

1) Open tank configuration menu (Setup menu > Tank > Load/Save Tank).

Press **OK** to edit the selected menu item.



### Load tank profile

Allows to select the tank configuration file saved in the USB pen drive and to set VISIO again.



**WARNING: By loading the TANK.TKL file contained in the USB pen drive onto the VISIO, the current tank profile will be lost.**

1) Select control through .

2) Press **OK** to confirm loading, or **ESC** to quit without saving.



**The TANK.TKL file can be loaded only if it is saved in the USB pen drive root directory.**



## Save tank profile

Allows saving the tank configuration file on the USB pen drive: it will be possible to load it again any time the same settings need to be retrieved.

1) Select control through .

2) Press **OK** to confirm saving, or **ESC** to quit without saving.



**If a TANK.TKL file is already present in the USB pen drive root directory, the file will be overwritten.**

## Language

Set the desired language.



Open language setting menu (Setup menu > Options > Language).

**The display will show the current setting below the selected item.**

Press **OK** to edit language.



1) Select a language through .

2) Press **OK** to save, or **ESC** to quit without saving.

## Units of measurement

Set unit of measurement for the values detected by the device.

### Flowrate units of measurement

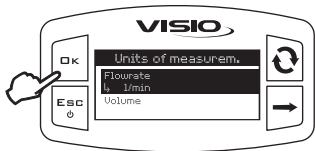

- 1) Open instant rate unit of measurement setting menu (Setup menu > Options > Units of measurement. > Flowrate).

**The display will show the current setting below the selected item.**

Press **OK** to select flowrate unit of measurement.

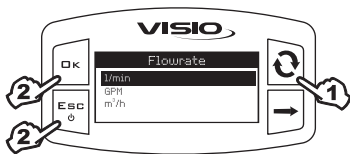

- 1) Select a unit through .

2) Press **OK** to save, or **ESC** to quit without saving.

### Volume units of measurement

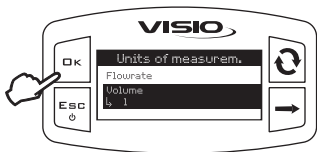

- 1) Open volume unit of measurement setting menu (Setup menu > Options > Units of measurement. > Volume).

**The display will show the current setting below the selected item.**

Press **OK** to select volume unit of measurement.

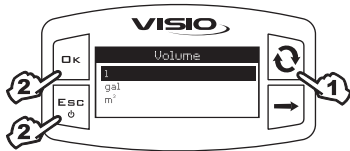

- 1) Select a unit through .

2) Press **OK** to save, or **ESC** to quit without saving.



## Display contrast

Set display contrast.

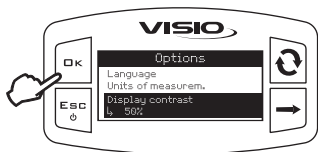



Open display contrast menu (Setup menu > Options > Display contrast).

**The display will show the current setting below the selected item.**

Press **OK** to edit the selected menu item.



1) Set a value through . Every time you press it, value will increase by 5% up to 100%. Use key  to decrease value by 5%.

2) Press **OK** to save, or **ESC** to quit without saving.

## Alarm tones

Enable/disable the alarm tones.

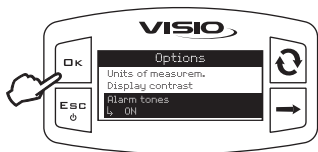

Open alarm tones menu (Setup menu > Options > Alarm tones).

**The display will show the current setting below the selected item.**

Press **OK** to edit the selected menu item.



1) Set status through .

2) Press **OK** to save, or **ESC** to quit without saving.

## Keytones

Enable/disable keytones.

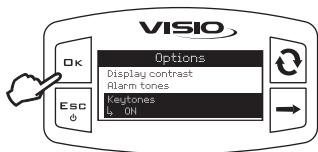

1) Open keytones menu (Setup menu > Options > Keytones).

**The display will show the current setting below the selected item.**

Press **OK** to edit the selected menu item.



1) Set status through .

2) Press **OK** to save, or **ESC** to quit without saving.

## Filling tolerance

Set the percentage value of pump deactivation advance during filling with respect to tank capacity, in order to reach the real quantity of fluid introduced into the tank more precisely.

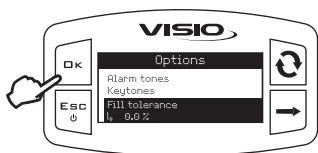

1) Open the filling tolerance menu (Setup menu > Tank > Fill tolerance).

**The display will show the current setting below the selected item.**

Press **OK** key to edit the selected menu item.



2) Set the filling tolerance value with the dedicated keys:

A) Press to move through digits.

B) Press a few times to edit the highlighted digit.

C) Press to save changes, or

D) Press to quit the page without confirming changes.

## CAN communication

Flowrate or level values can also be measured by connecting VISIO to a computer of the Bravo 300S RCU or Bravo 400S series (ASSEMBLY DIAGRAMS). In this case data are sent to VISIO directly by the computer RCU through the CAN bus connection. Activate the function as follows:

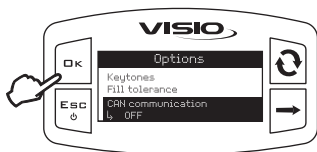

- 1) Open CAN communication menu (Setup menu > Options > CAN communication). **The display will show the current setting below the selected item.**  
Press **OK** to edit the selected menu item.



- 1) Set status through  .
- 2) Press **OK** to save, or **ESC** to quit without saving.



If CAN communication is active, the corresponding item will also be displayed under the "Test" Menu.

## Operating mode

Set required operating mode.

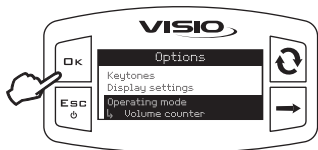

Open operating mode menu (Setup menu > Options > Operating mode).

**The display will show the current setting below the selected item.**

Press **OK** to change the operating mode.



1) Select the required operating mode

through .

2) Press **OK** to save, or **ESC** to quit without saving.

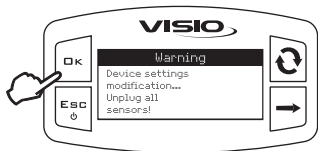

**WARNING: Once **OK** is pressed, the page on the side will be displayed.**

**Before changing operating mode, make sure that all sensors are DISCONNECTED from the device.**

Press **OK** to confirm changes.

**Connect the sensors REQUIRED FOR THE SET OPERATING MODE.**

## Setup management

VISIO settings can be loaded from or saved on a USB pen drive in order to reconfigure it if required, fix problems or set another VISIO with no need to repeat all manual operations.



Once installation is completed, and VISIO operation has been checked, we recommend to save all settings onto a USB pen drive.

To be able to use the following functions it is necessary to insert a USB pen drive in the relevant port at the bottom of VISIO.



1) Open Setup management menu (Setup menu > Setup management).

Press **OK** to edit the selected menu item.



### Load setup

Allows to select a configuration file saved in the USB pen drive and to set VISIO again.

**WARNING:** By loading the **SETUP.BIN** file contained in the USB pen drive onto the VISIO, all current settings will be lost.

1) Select the desired control through  key.

2) Press **OK** to confirm loading, or **ESC** to quit without saving.

The **SETUP.BIN** file can be loaded only if it is saved in the USB pen drive root directory.

If setup download involves changing operating mode and using different sensors than the ones in use, make sure that all sensors are **DISCONNECTED** from the device.

Press **OK** to confirm loading.

Reconnect sensors.



## Save setup

Allows saving VISIO configuration file on the USB pen drive: it will be possible to load it again any time the same settings need to be retrieved.

1) Select the desired control through



key.

2) Press **OK** to confirm saving, or **ESC** to quit without saving.



**If a SETUP.BIN file is already present in the USB pen drive root directory, the file will be overwritten.**

## Test menu

This menu allows user to view some data and carry out an operation test of VISIO:

**- Firmware version:**

the display shows the firmware version installed.

**- Battery voltage:**

the display shows the power voltage of the device.

### Display test

Display test checks the device display correct operation.

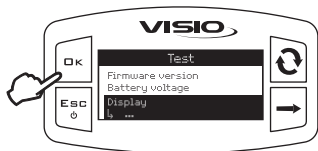

1) Open display test menu (Setup menu > Test > Display).

Press **OK** to perform the test.

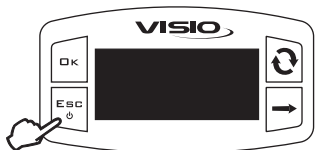

All pixels on display are turned on.

Press **ESC** to go back to previous page.

### Keys test

Keys test checks the device keys correct operation.

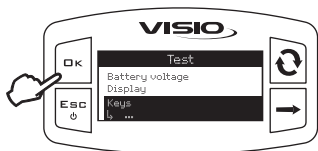

Open keys test menu (Setup menu > Test > Keys).

Press **OK** to perform the test.



1) Press any key and the corresponding display area will turn on.

Press **ESC** to quit: as soon as you acknowledge the switch-on on of the corresponding area on the display, device will go back to previous page.



Sensors test checks correct operation of the sensors connected to the device.

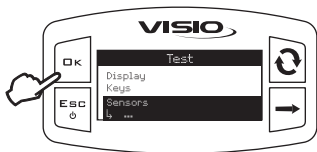

Open sensors test menu (Setup menu > Test > Sensors).

Press **OK** to perform the test.

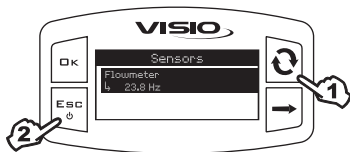

The display will show the current sensor reading below the selected item.

1) Several sensors could be displayed, depending on the set operating mode. In this case, select required sensor

through .

2) Press **ESC** to quit.



Open CAN communication test (Setup menu > Test > CAN communication).

The display shows CAN communication status.



**The CAN device shown is only an example.**

The main page shows the display divided into three horizontal parts:

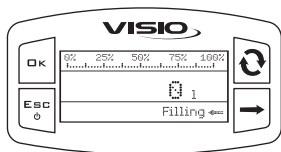

**- top part:**

the progress bar shows the tank level in percentage.

**- central part:**

the value represents the volume of fluid inside the tank.

**- bottom part:**

the item **Filling** refers to the key on the side, which allows to enter the filling procedure management menu.



1) Press  key for two seconds to open the menu for setting the filling quantity.



2) Set filling quantity:

A) Press to move through digits.

B) Press a few times to edit the highlighted digit.

C) Press to save changes, or

D) Press to quit the page without confirming changes.





3) Keep  key pressed for two seconds. Filling starts.



The display shows the following data:

- **top part:** set filling quantity;
- **central part:** partial totalizer;
- **bottom part:** tank level in percentage.

Press the  key several times to view a value in extended mode until required value is on display central part.

 **Displayed values cannot be edited.**

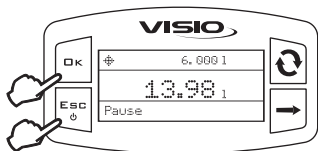

Tank filling can be interrupted at any time by pressing **ESC**. **Pause** message will be shown at the bottom of the display. Press **OK** key to resume filling; press **ESC** key to finally stop filling and display will go back to initial page.



When set quantity is reached, filling stops automatically. **Completed** message will be shown at the bottom of the display.

## MAINTENANCE / DIAGNOSTICS / REPAIRS

- Clean only with a soft wet cloth.
- Do not use aggressive detergents or products.
- Do not clean equipment with direct water jets.

### Troubleshooting

FAULT	CAUSE	REMEDY
VISIO is off or does not switch on	No power supply	Check power cable connections
	Device is OFF	Press the ON key
VISIO shows wrong data	Wrong setup	Check displayed data setup
	Sensor fault	Contact the nearest Assistance Center
	VISIO fault	
Filling pump (if any) does not start	Pump Stop Module not powered	Check power supply connection

### END OF LIFE DISPOSAL

Dispose of the system in compliance with the established legislation in the country of use.

## TECHNICAL DATA

### Device technical data

Description	VISIO
Display	Graphic LCD, 128 x 64 pixels, back-lighting
Power supply voltage	9 ÷ 16 Vdc
Protection against short-circuit	•
Protection against polarity inversion	•
Max. frequency	1.2 KHz
Analog inputs	4 ÷ 20 mA
Digital output - Max current	100 mA
Maximum power input (with no sensors connected)	160 mA
Operating temperature	-20 °C ÷ 70 °C -4 °F ÷ +158 °F
Storage temperature	-30 °C ÷ 80 °C -22 °F ÷ +176 °F
Size	126 x 79 x 66 mm
Weight	245 g

## Setup menu

	Data	Min.	Max.	Default	UoM	Notes
<b>Calib. flowmeter</b>	Calibration	1	10000	OFF	pls/l	--
<b>Alarms</b>	Reserve tank	0.1	100 0	50	l/min.	Alarm can be disabled by setting value to "OFF"
	Max. level	0.1	1000	OFF	l/min.	Alarm can be disabled by setting value to "OFF"
<b>Display</b>	Contrast	0	100	50	%	--
<b>Options</b>	Language	-	-	English	-	<b>Available languages:</b> Italiano, English, Español, Português, Français, Deutsch, Cesky, Polski, Русский, Magyar, コホン.
	Flowrate units of measurement	-	-	l/min.	l/min.	<b>Available units of measurement:</b> l/min, GPM, m <sup>3</sup> /h
	Volume units of measurement	-	-	l	liters	<b>Available units of measurement:</b> l, gal, m <sup>3</sup>
	Filling tolerance	0.1	50.0	00.0	%	--

## GUARANTEE TERMS

---

1. ARAG s.r.l. guarantees this apparatus for a period of 360 days (1 year) from the date of sale to the client user (date of the goods delivery note).  
The components of the apparatus, that in the unappealable opinion of ARAG are faulty due to an original defect in the material or production process, will be repaired or replaced free of charge at the nearest Assistance Center operating at the moment the request for intervention is made. The following costs are excluded:
  - disassembly and reassembly of the apparatus from the original system;
  - transport of the apparatus to the Assistance Center.
2. The following are not covered by the guarantee:
  - damage caused by transport (scratches, dents and similar);
  - damage due to incorrect installation or to faults originating from insufficient or inadequate characteristics of the electrical system, or to alterations resulting from environmental, climatic or other conditions;
  - damage due to the use of unsuitable chemical products, for spraying, watering, weedkilling or any other crop treatment, that may damage the apparatus;
  - malfunctioning caused by negligence, mishandling, lack of know how, repairs or modifications carried out by unauthorized personnel;
  - incorrect installation and regulation;
  - damage or malfunction caused by the lack of ordinary maintenance, such as cleaning of filters, nozzles, etc.;
  - anything that can be considered to be normal wear and tear.
3. Repairing the apparatus will be carried out within time limits compatible with the organizational needs of the Assistance Center.  
No guarantee conditions will be recognized for those units or components that have not been previously washed and cleaned to remove residue of the products used;
4. Repairs carried out under guarantee are guaranteed for one year (360 days) from the replacement or repair date.
5. ARAG will not recognize any further expressed or intended guarantees, apart from those listed here.  
No representative or retailer is authorized to take on any other responsibility relative to ARAG products.  
The period of the guarantees recognized by law, including the commercial guarantees and allowances for special purposes are limited, in length of time, to the validities given here.  
In no case will ARAG recognize loss of profits, either direct, indirect, special or subsequent to any damage.
6. The parts replaced under guarantee remain the property of ARAG.
7. All safety information present in the sales documents regarding limits in use, performance and product characteristics must be transferred to the end user as a responsibility of the purchaser.
8. Any controversy must be presented to the Reggio Emilia Law Court.



# Conformity Declaration



ARAG s.r.l.  
Via Palladio, 5/A  
42048 Rubiera (RE) - Italy  
P.IVA 01801480359

Dichiara

che il prodotto  
descrizione: **Visualizzatore multifunzione**  
modello: **Visio**  
serie: **4670610**

risponde ai requisiti di conformità contemplati nella seguente Direttiva Europea:  
**2004/108/CE** e successive modificazioni  
(Compatibilità elettromagnetica)

Riferimenti alle Norme Applicate:  
**UNI EN ISO 14982**  
(Macchine agricole e forestali - Compatibilità elettromagnetica  
Metodi di prova e criteri di accettazione)

Rubiera, 6 Marzo 2013

*Giovanni Montorsi*

(Presidente)

---

*Only use genuine ARAG accessories or spare parts to make sure manufacturer guaranteed safety conditions are maintained in time. Always refer to ARAG spare parts catalog.*



42048 RUBIERA (Reggio Emilia) - ITALY  
Via Palladio, 5/A

Tel. +39 0522 622011

Fax +39 0522 628944

[www.aragnet.com](http://www.aragnet.com)

[info@aragnet.com](mailto:info@aragnet.com)